

This Page Is Inserted by IFW Operations
and is not a part of the Official Record

BEST AVAILABLE IMAGES

Defective images within this document are accurate representations of the original documents submitted by the applicant.

Defects in the images may include (but are not limited to):

- BLACK BORDERS
- TEXT CUT OFF AT TOP, BOTTOM OR SIDES
- FADED TEXT
- ILLEGIBLE TEXT
- SKEWED/SLANTED IMAGES
- COLORED PHOTOS
- BLACK OR VERY BLACK AND WHITE DARK PHOTOS
- GRAY SCALE DOCUMENTS

IMAGES ARE BEST AVAILABLE COPY.

**As rescanning documents *will not* correct images,
please do not report the images to the
Image Problem Mailbox.**

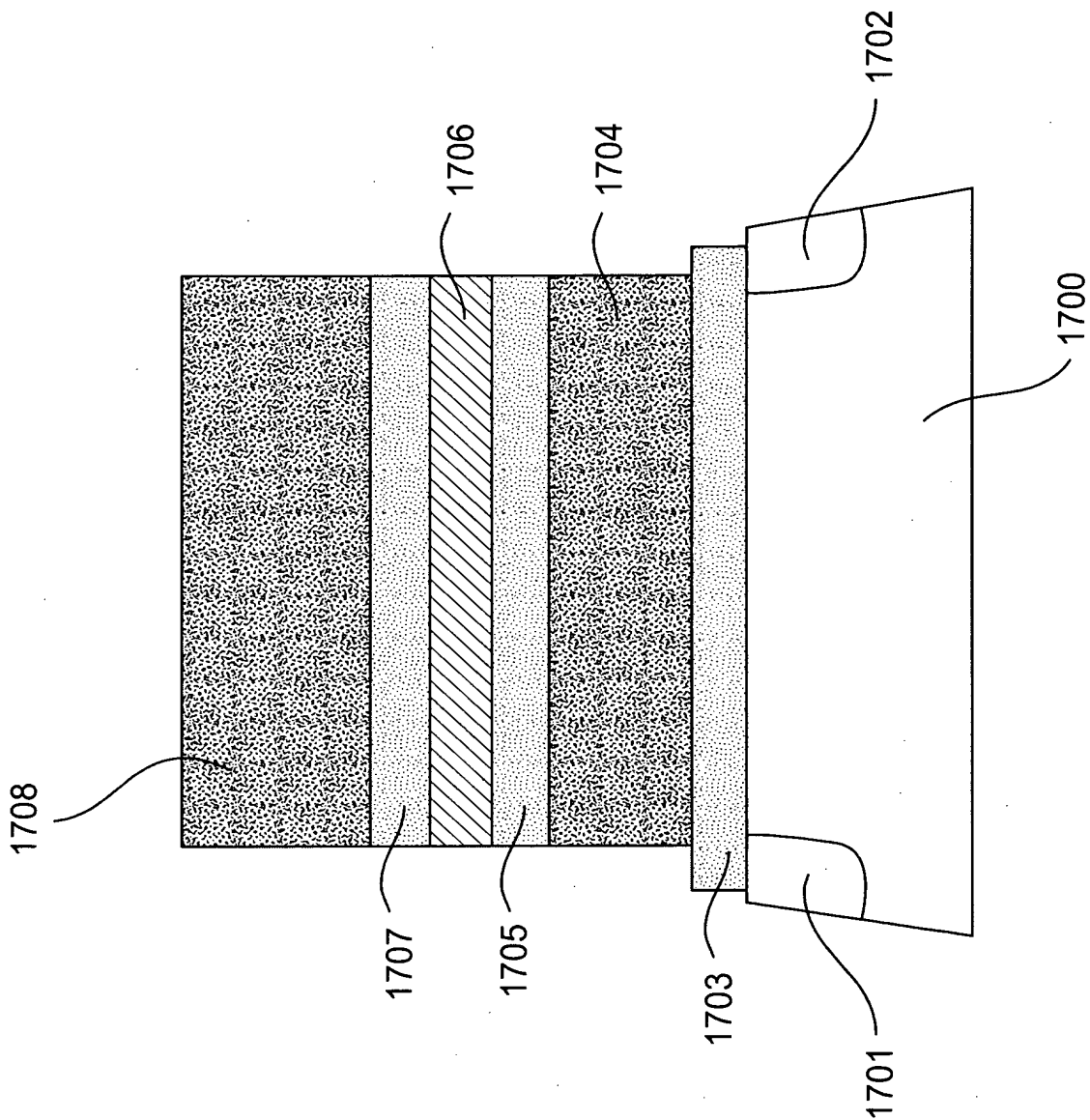

FIG. 1

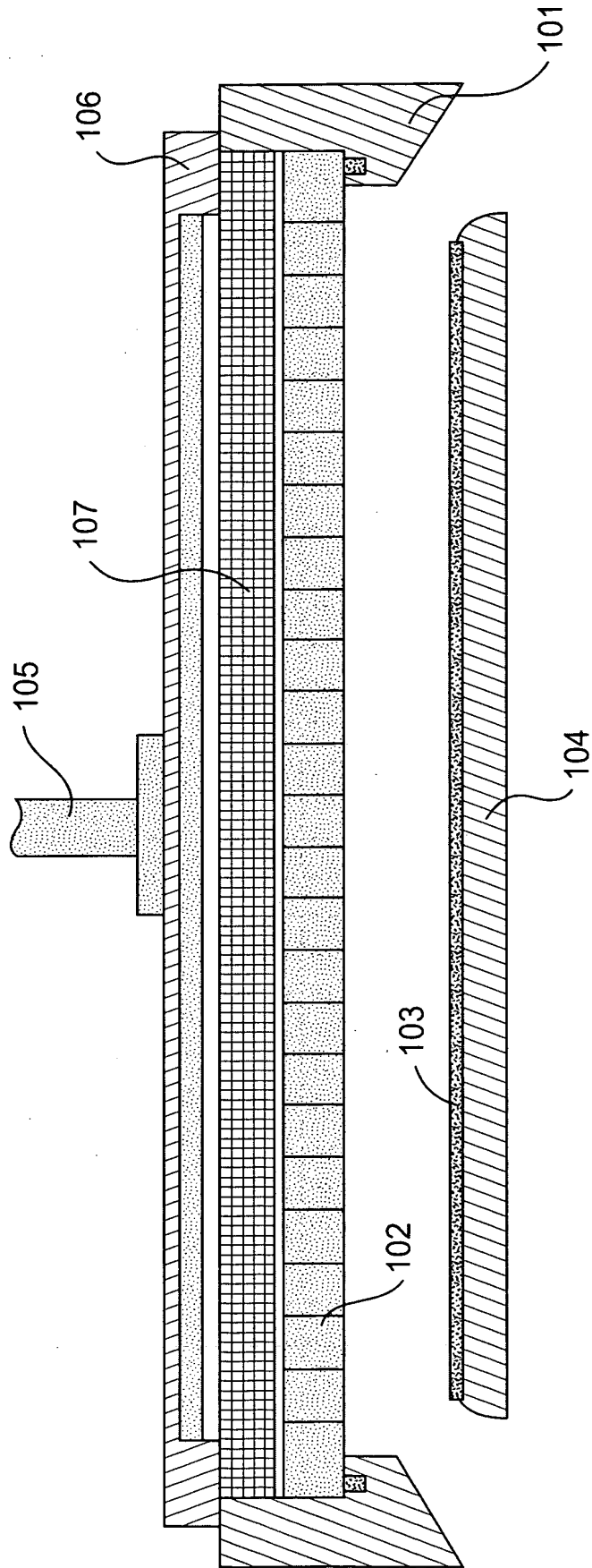

FIG. 2

3/29

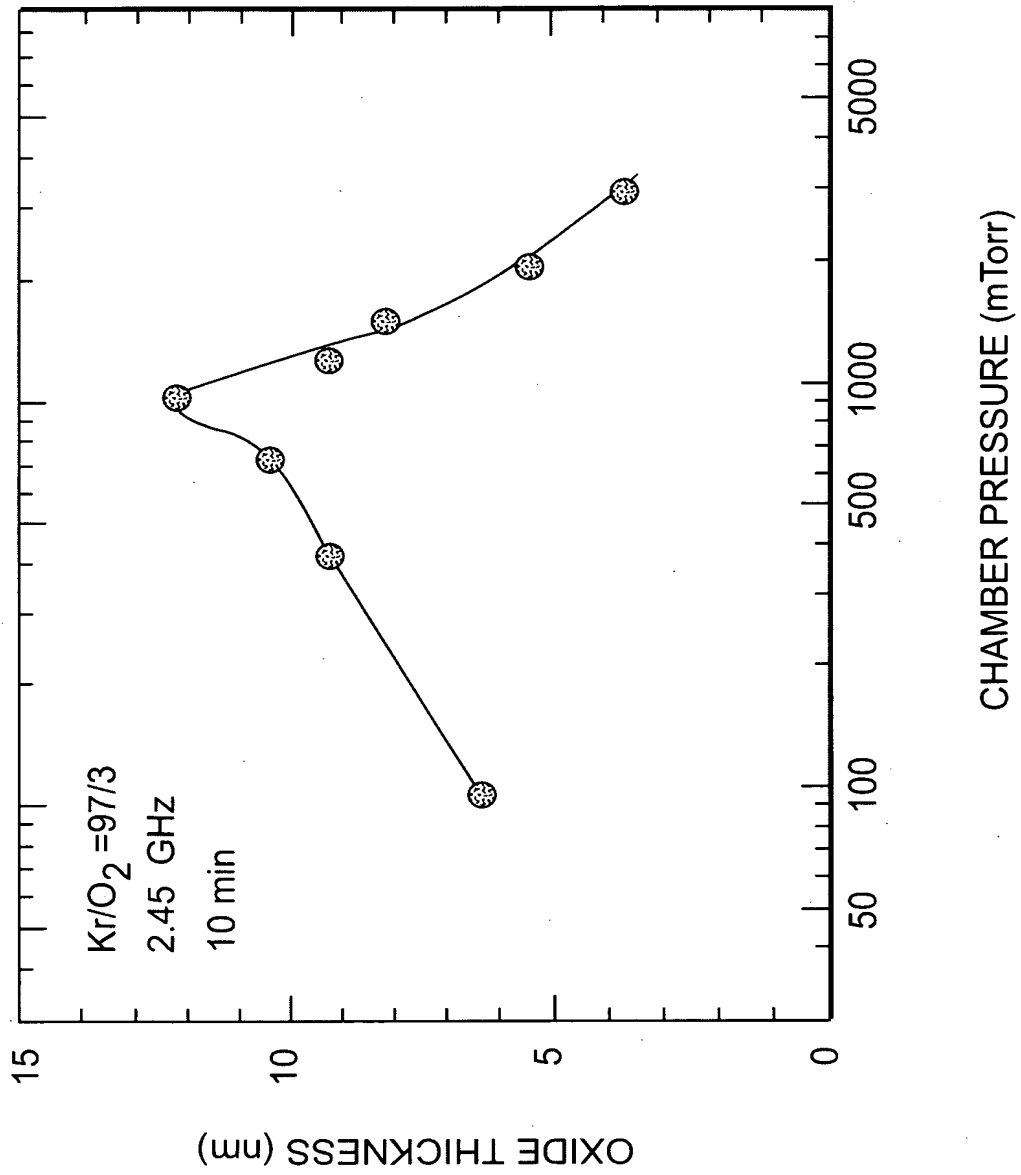

FIG. 3

4/29

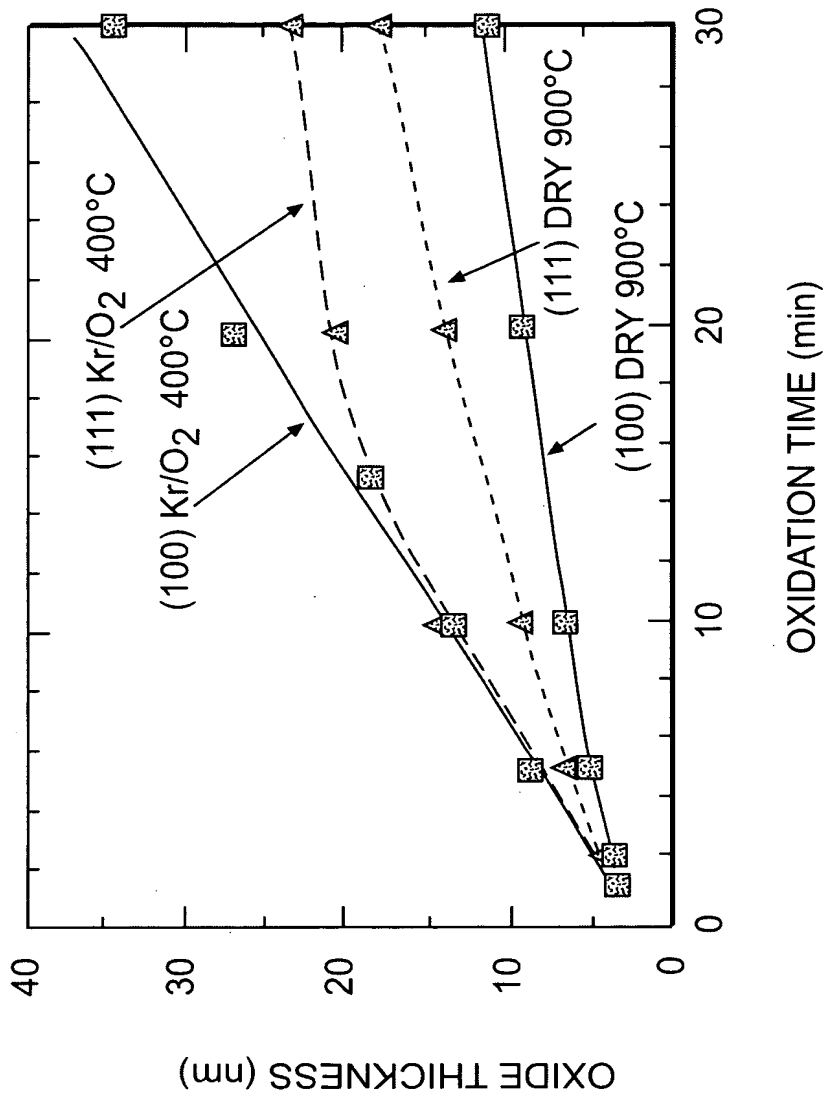

FIG. 4

5/29

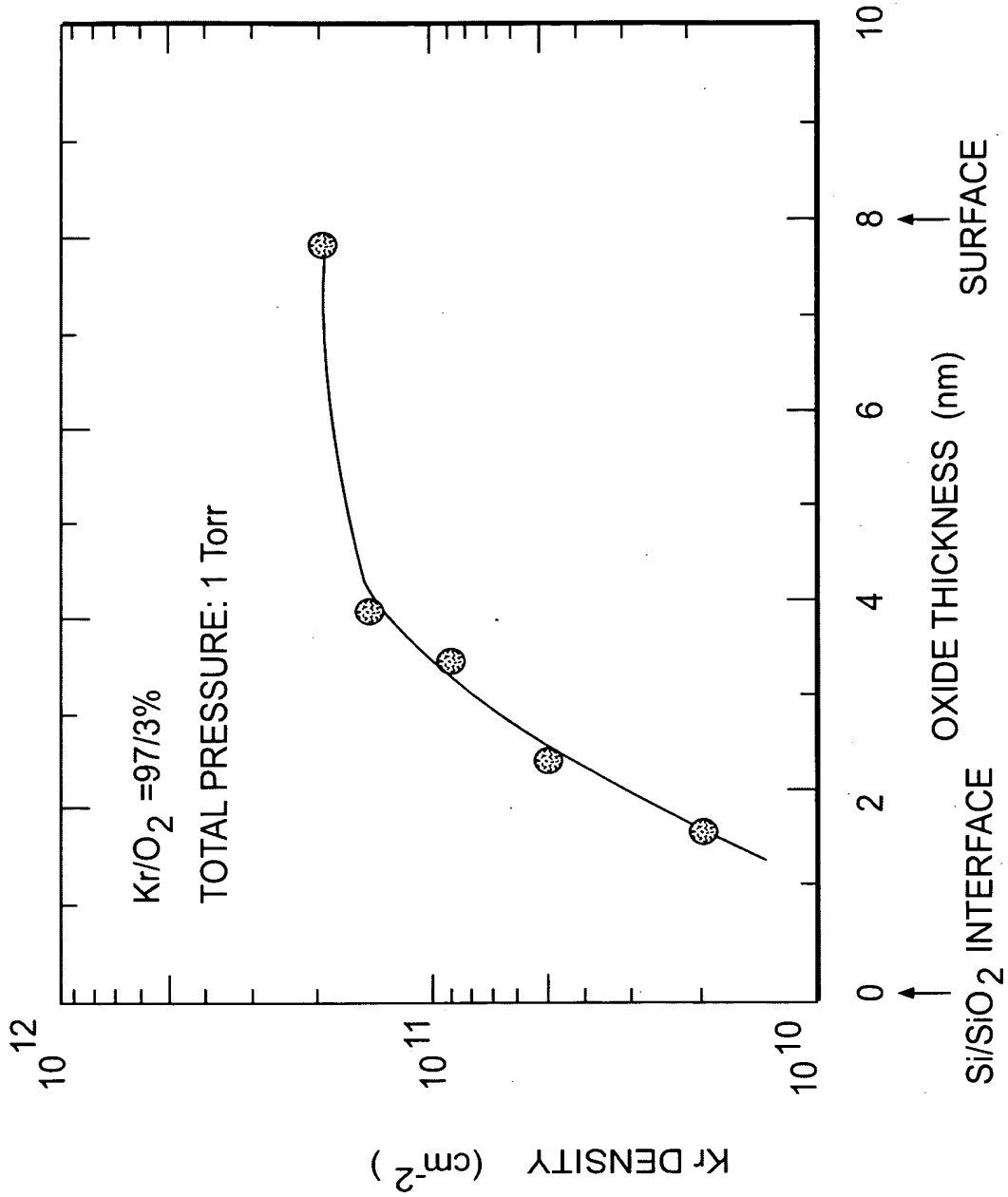

FIG. 5

6/29

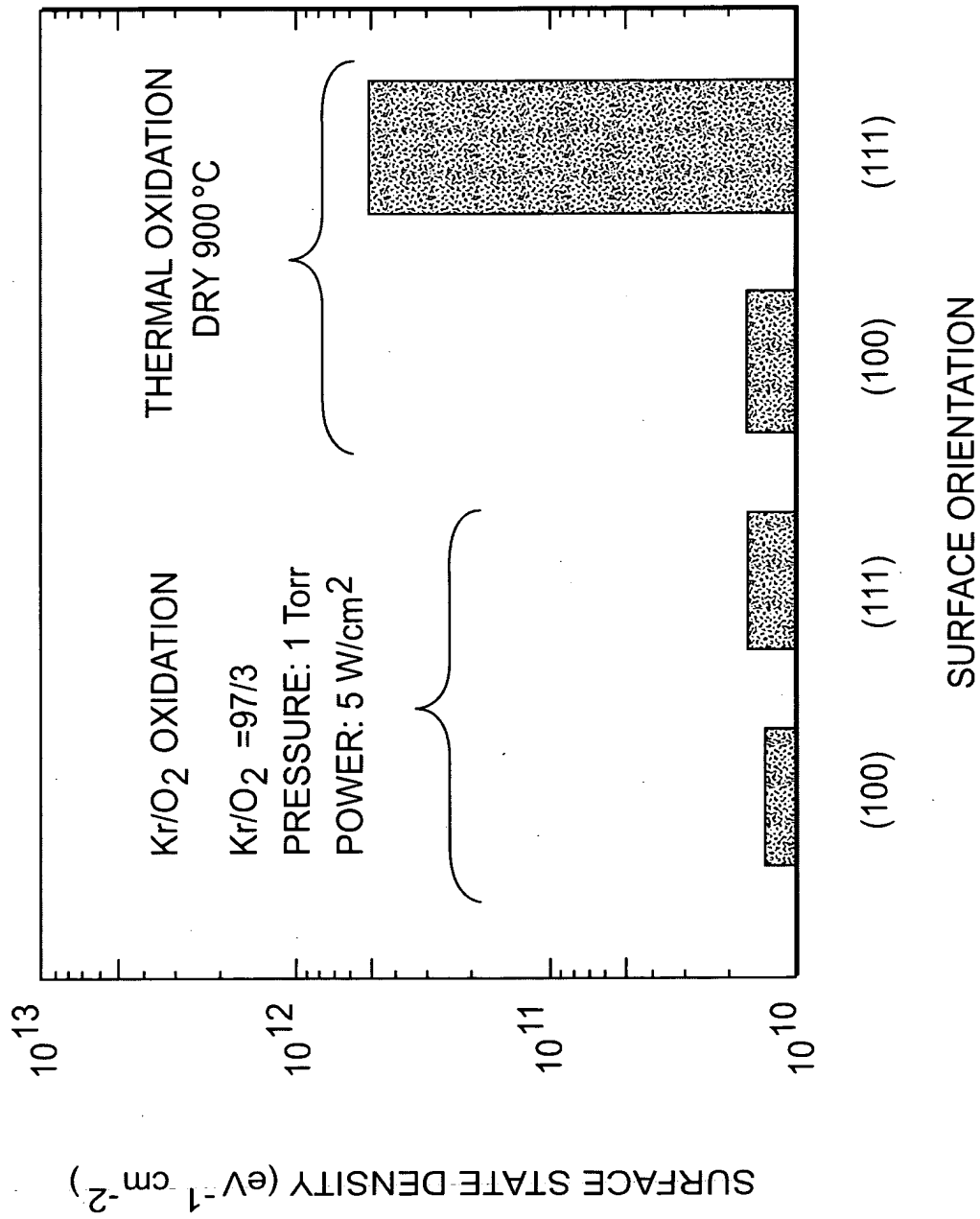

FIG. 6

7/29

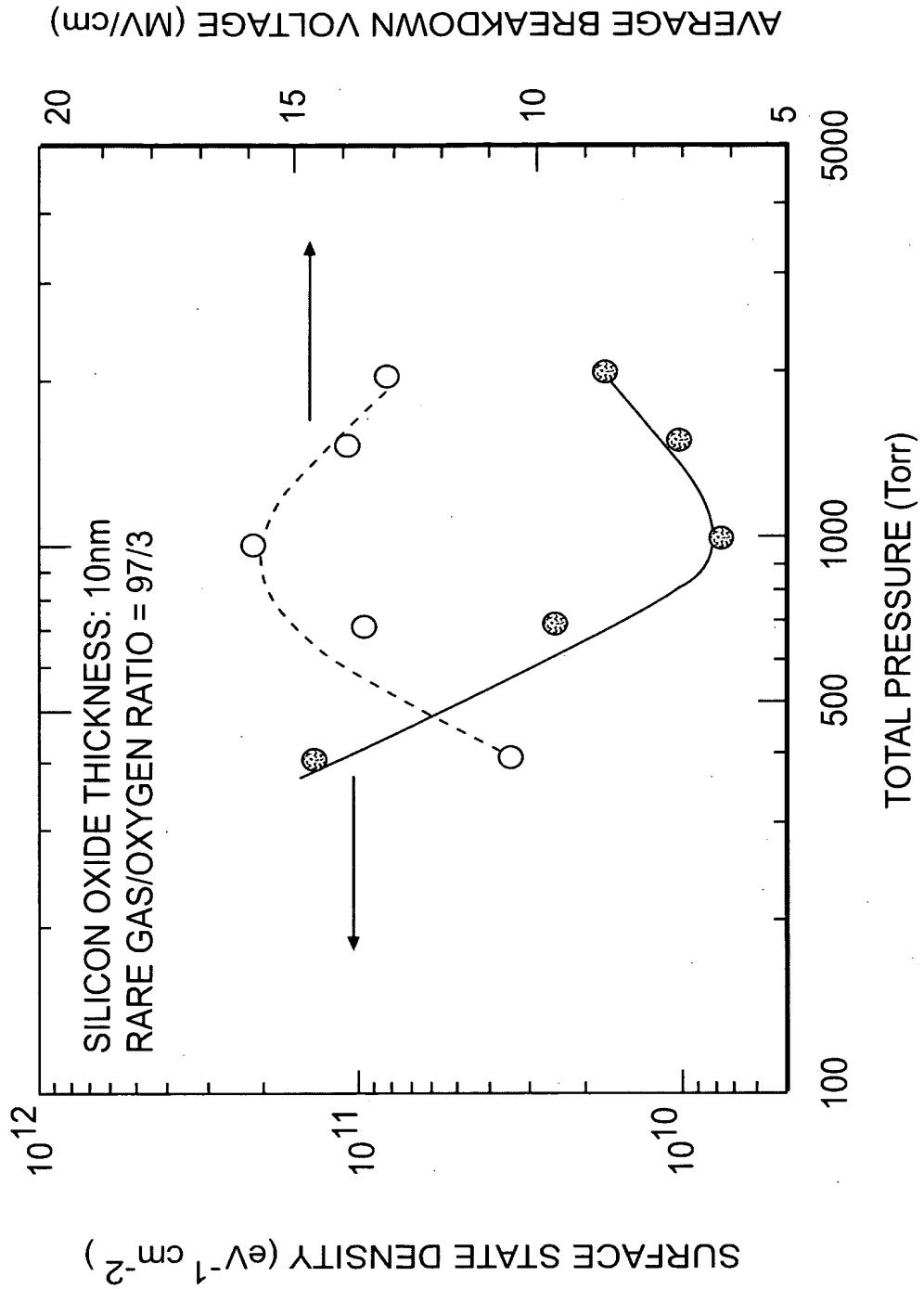

FIG. 7

8/29

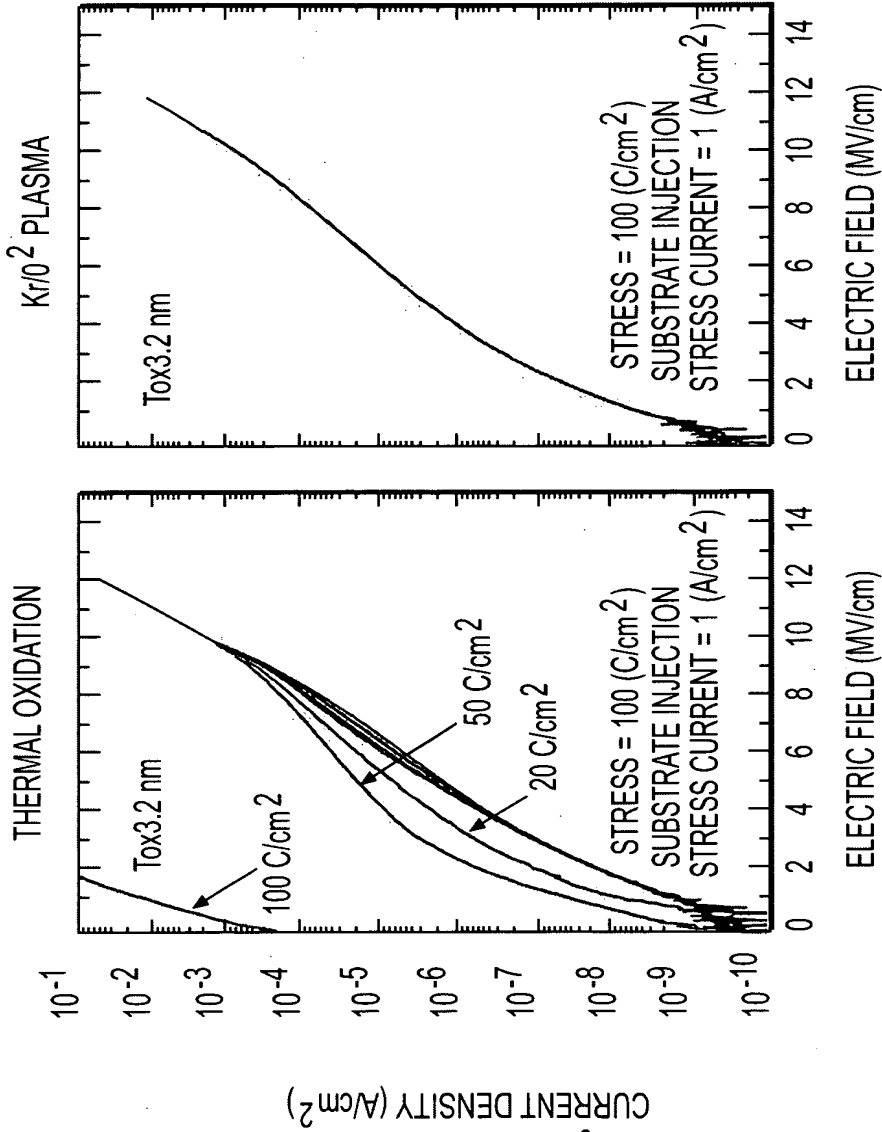

FIG. 8A

FIG. 8B

9/29

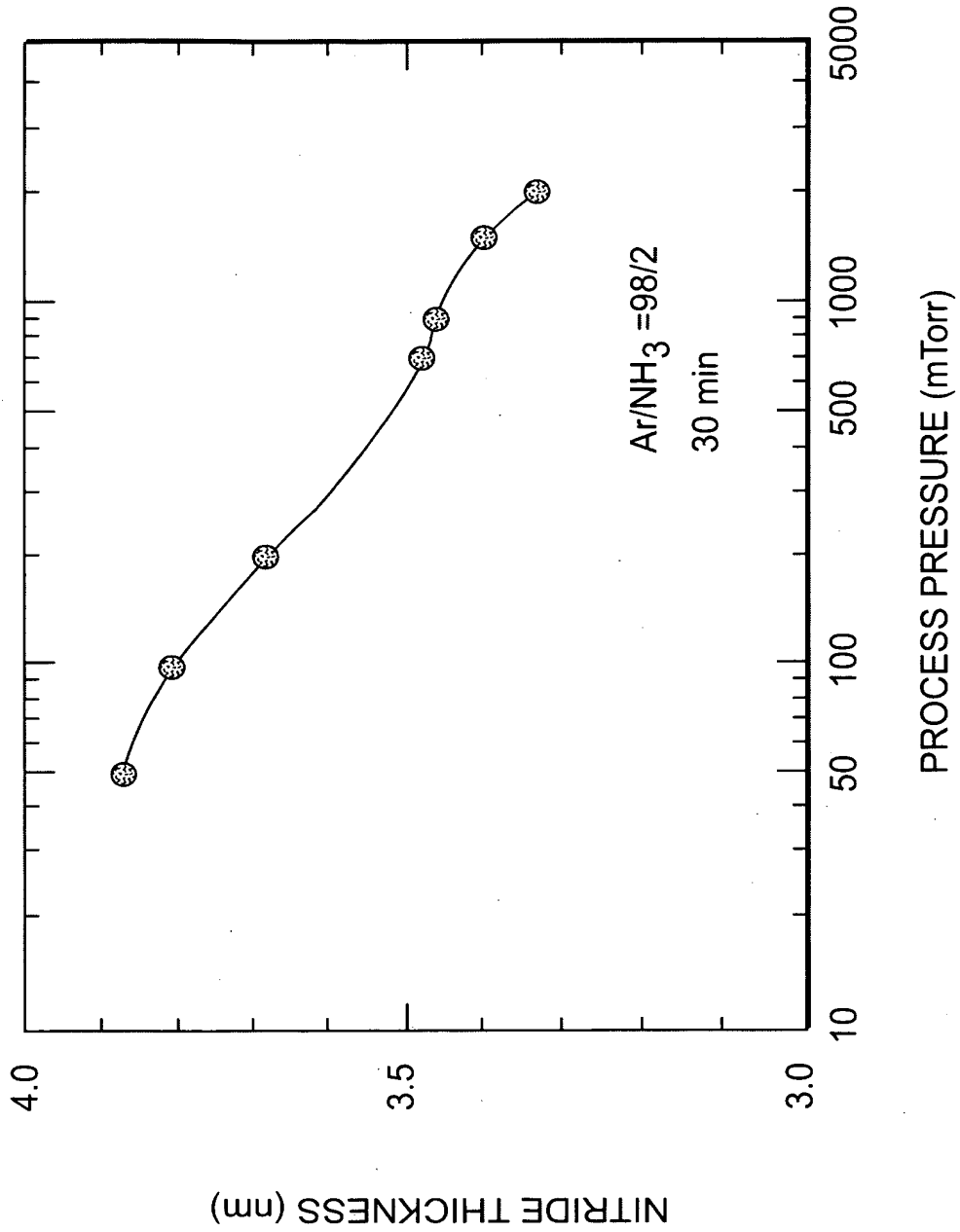

FIG. 9

10/29

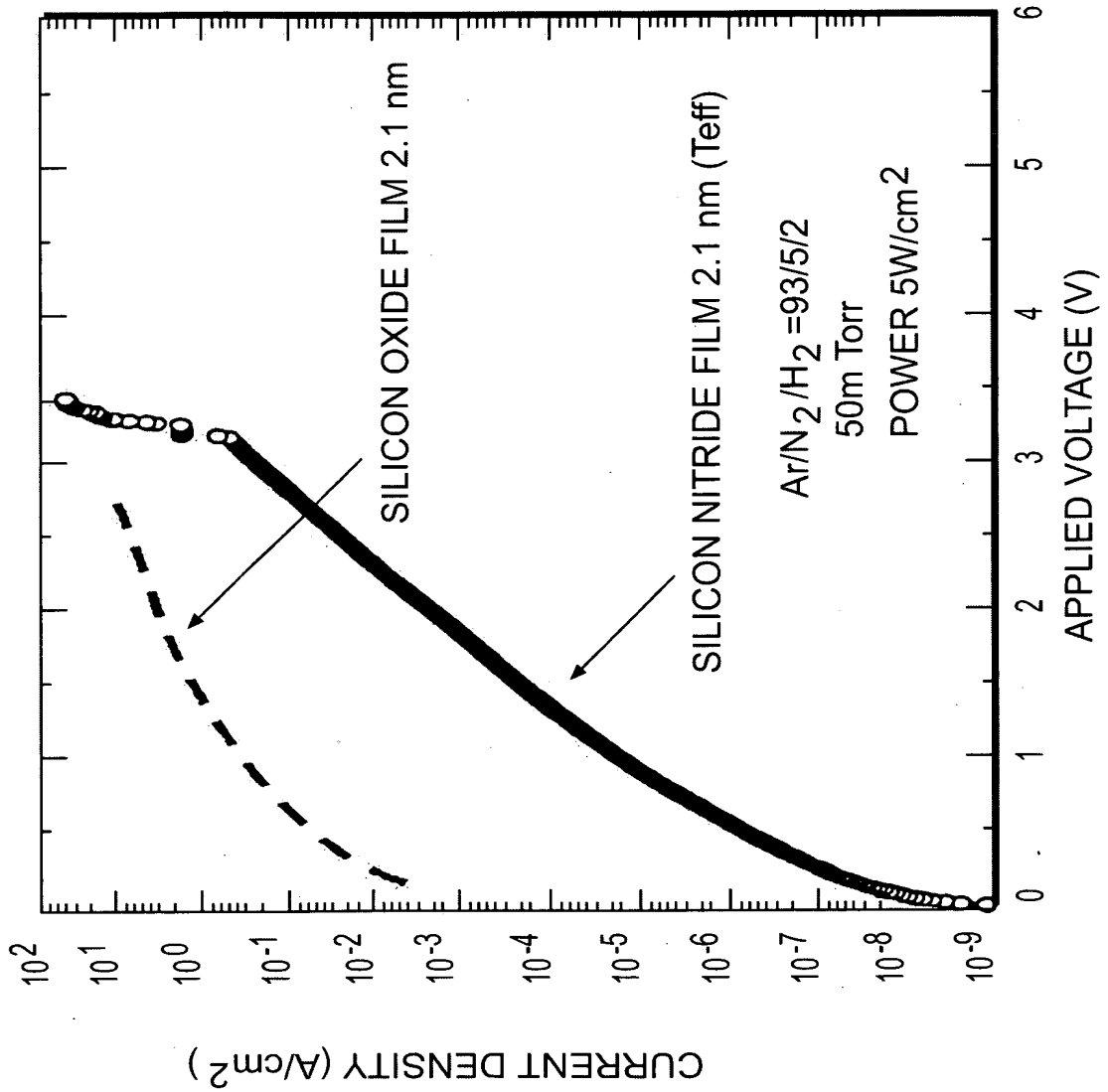

FIG. 10

11/29

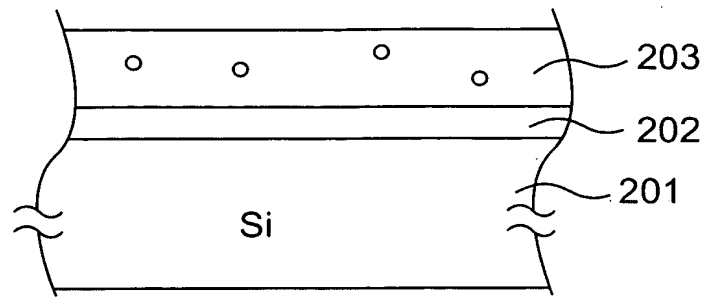
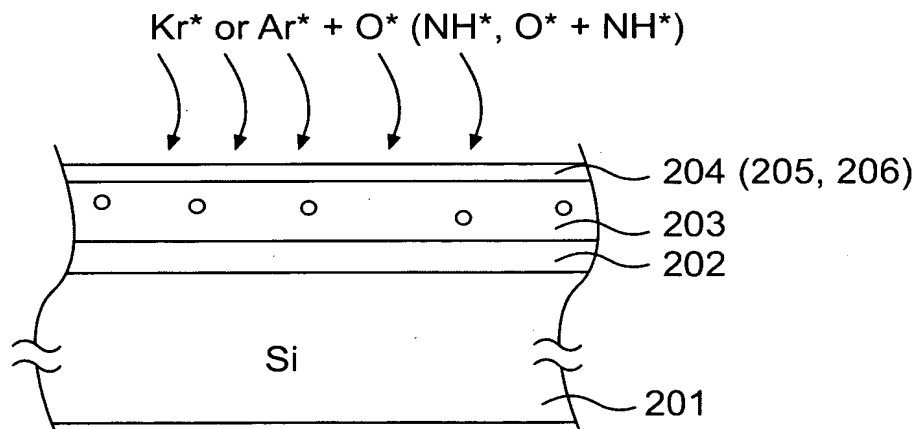

FIG. 11A



- 204: SiO_2 ← O^*
205: Si_3N_4 ← NH^*
206: SiO_N ← $\text{O}^* + \text{NH}^*$

FIG. 11B

12/29

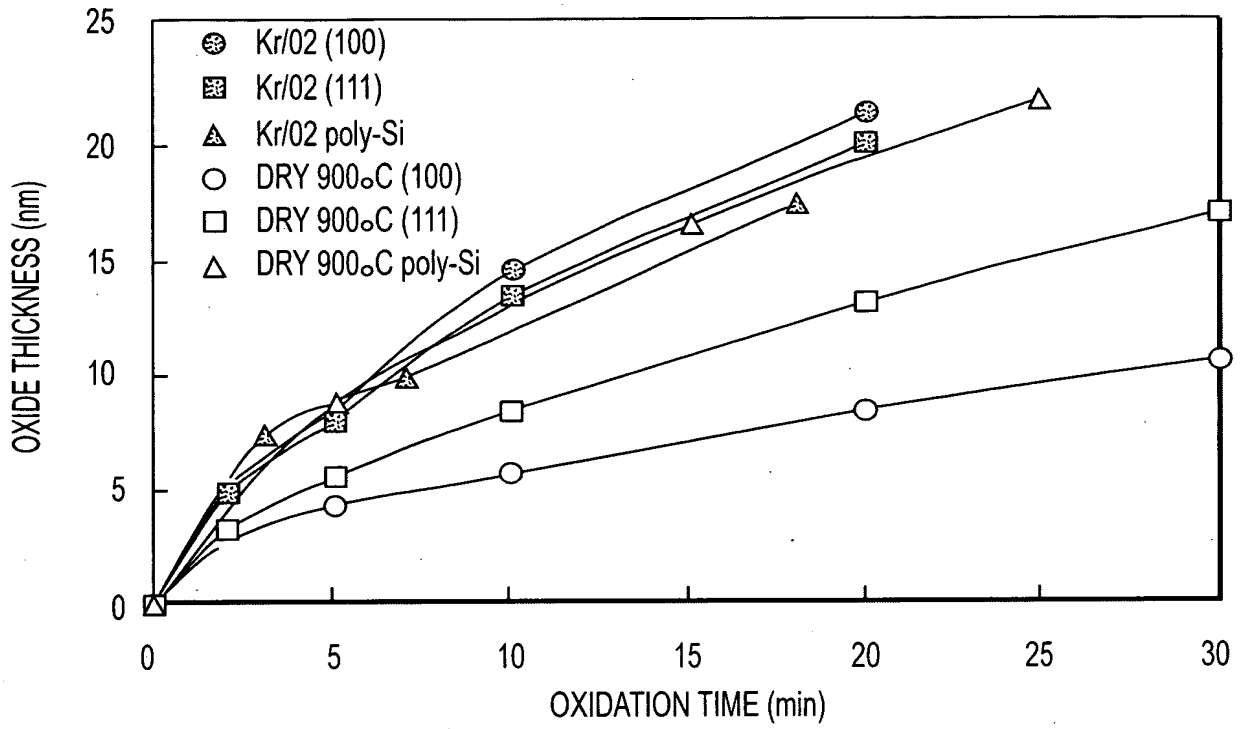

FIG. 12

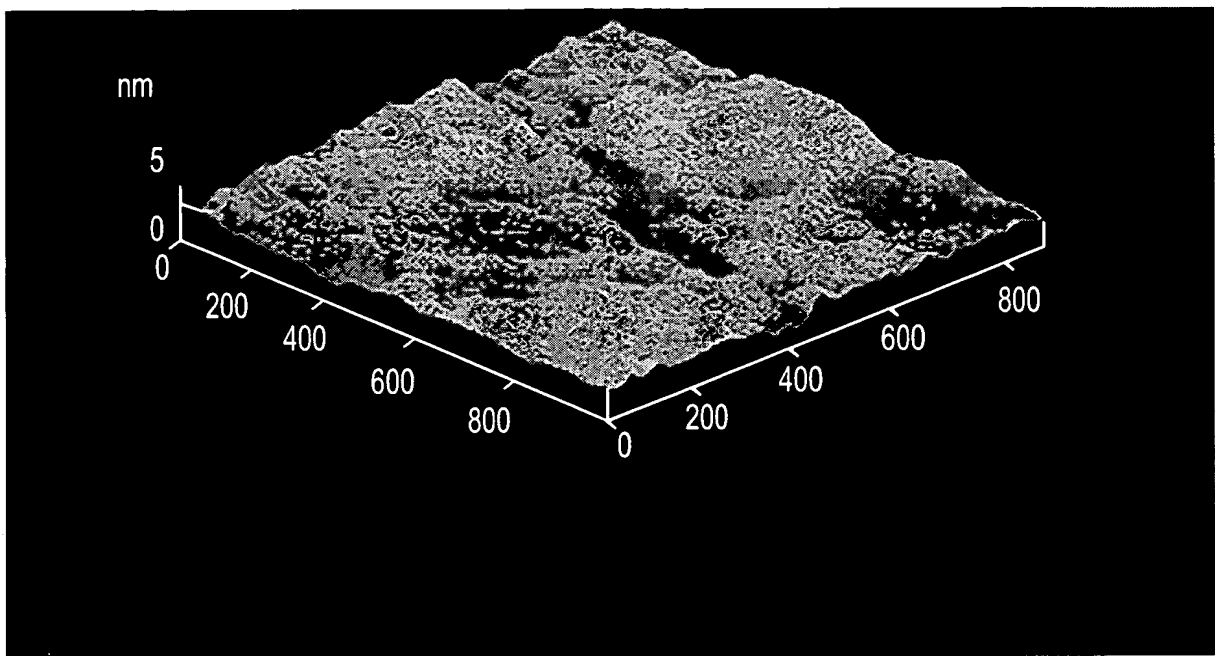

FIG. 13A

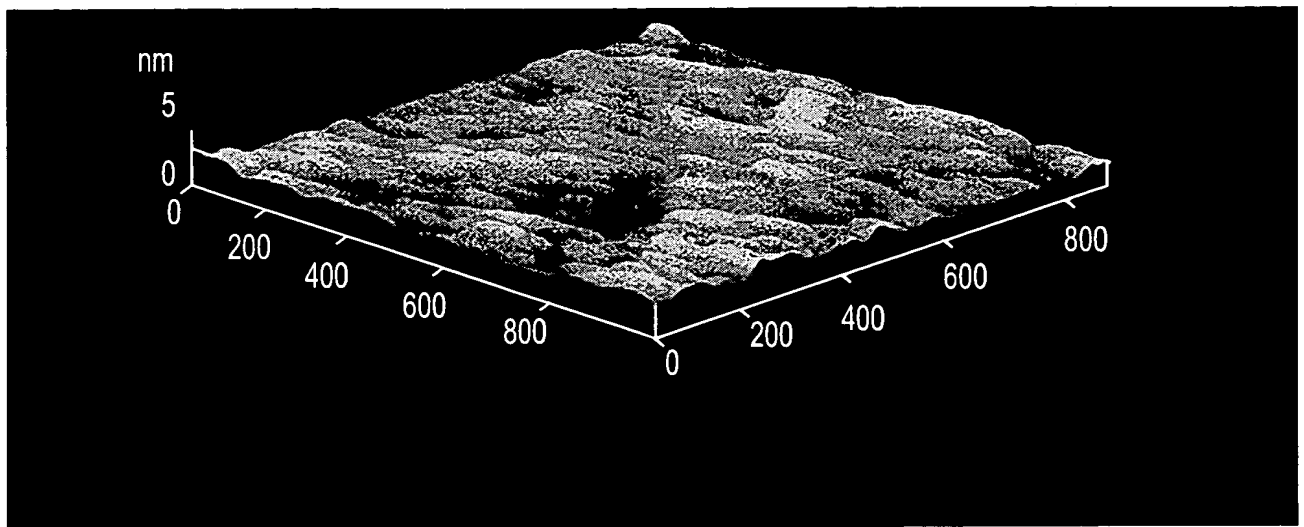

FIG. 13B

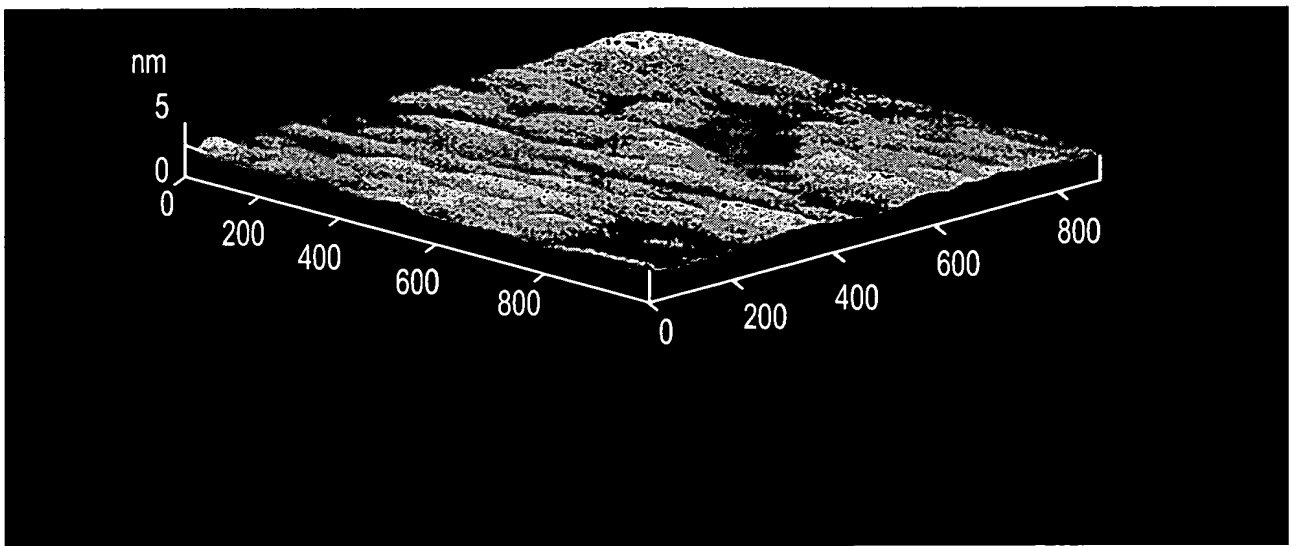

FIG. 13C

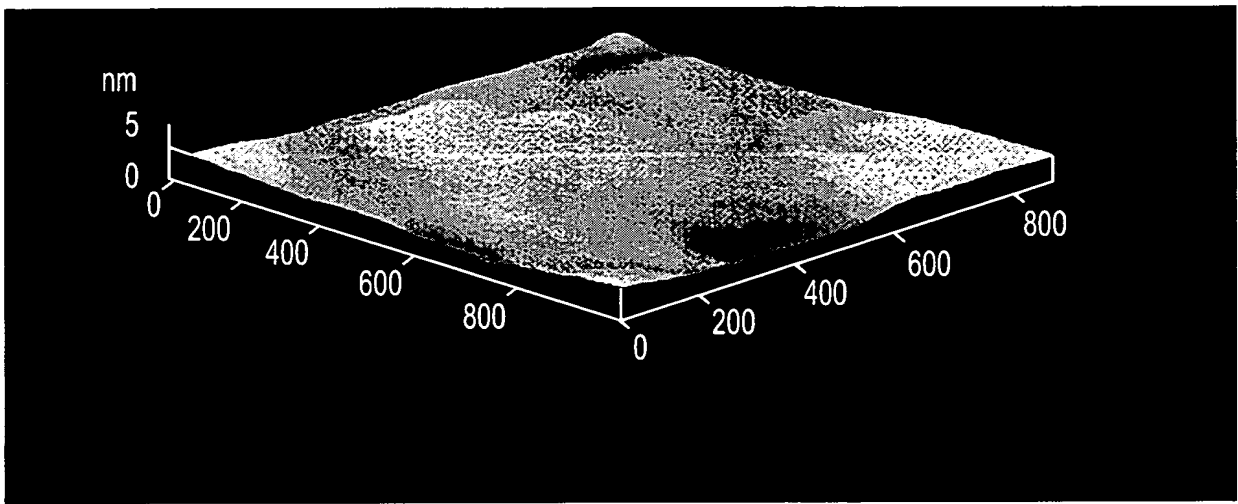

FIG. 14A

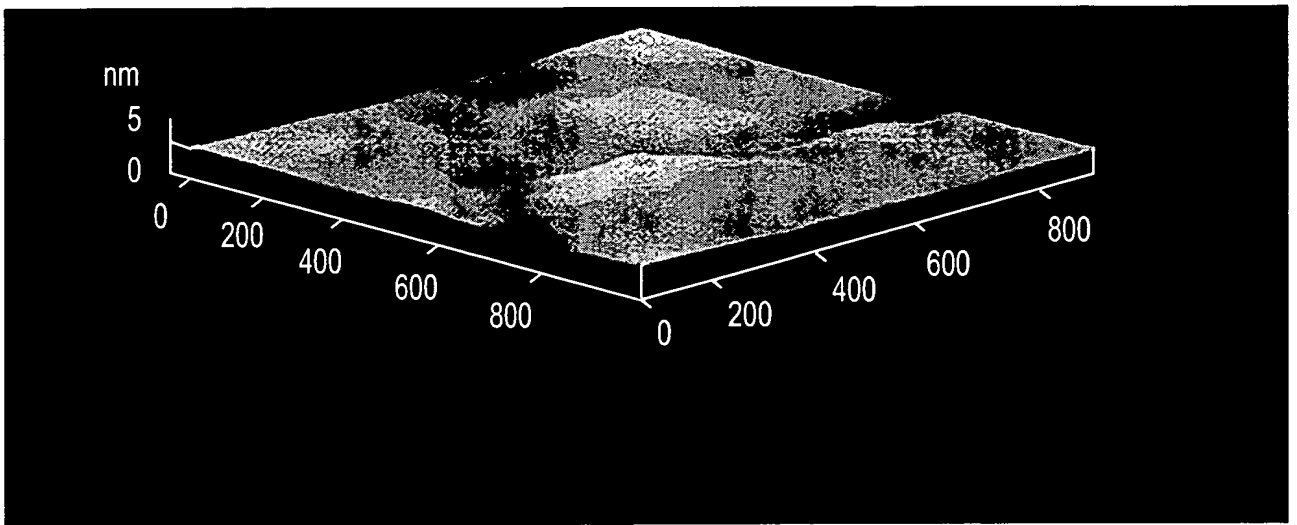

FIG. 14B

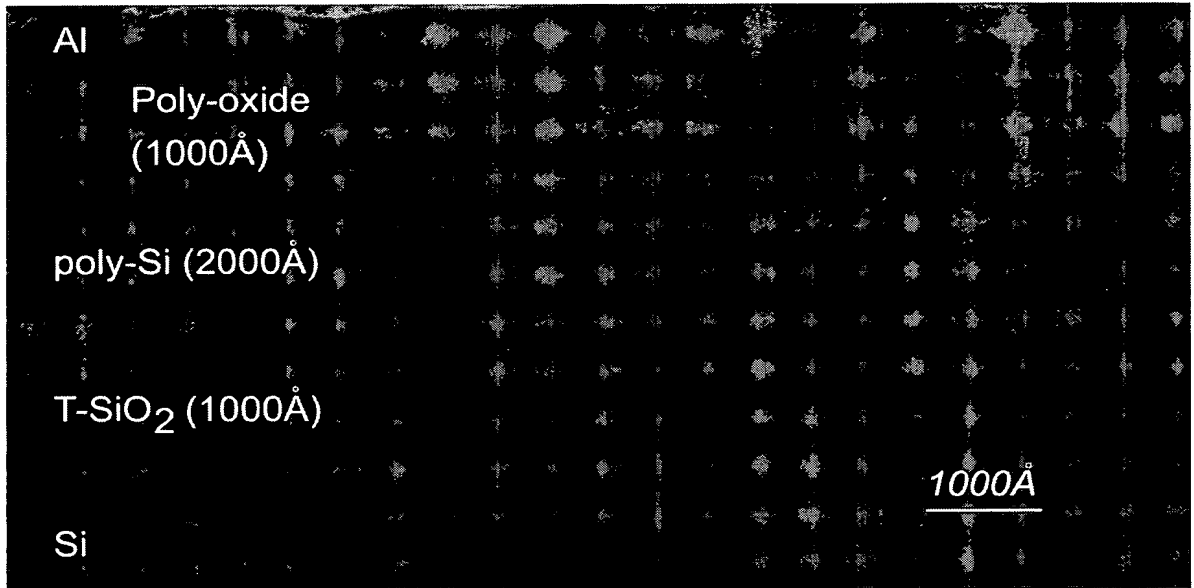

FIG. 15A

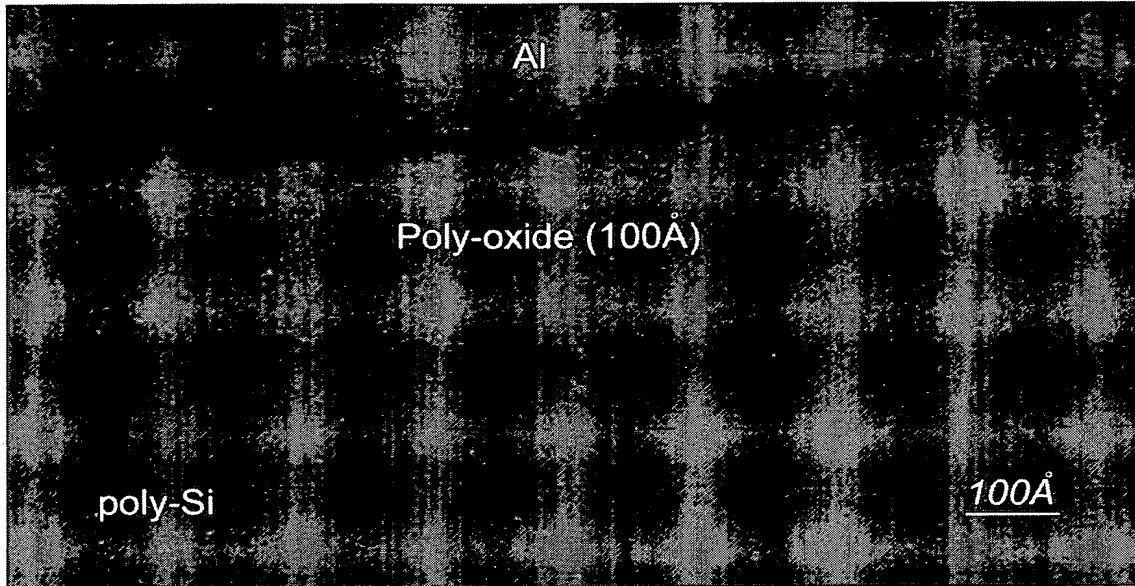

FIG. 15B

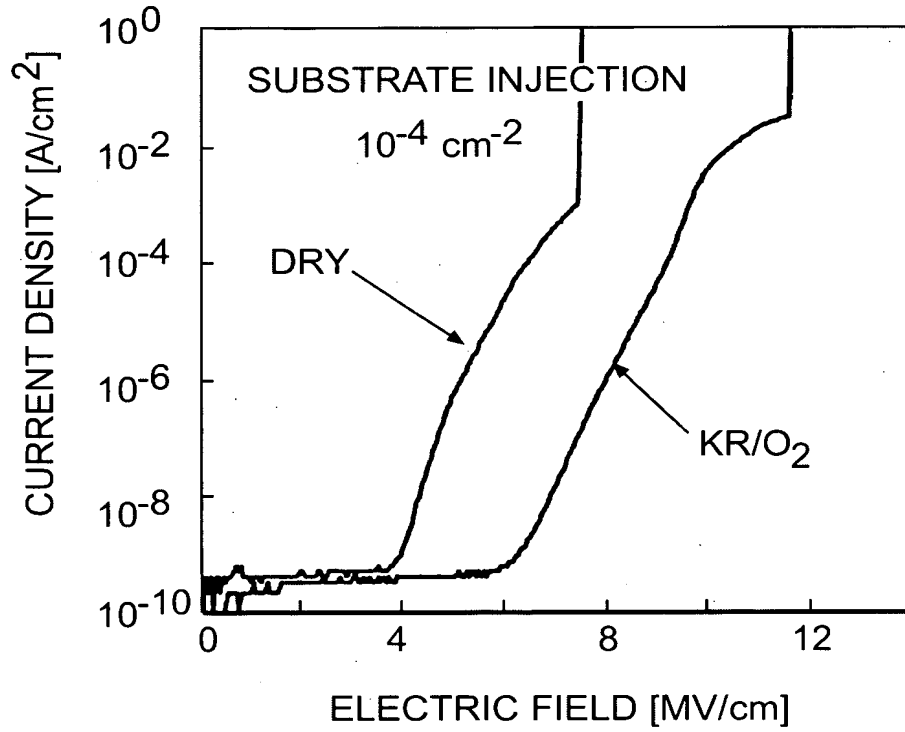

FIG. 16

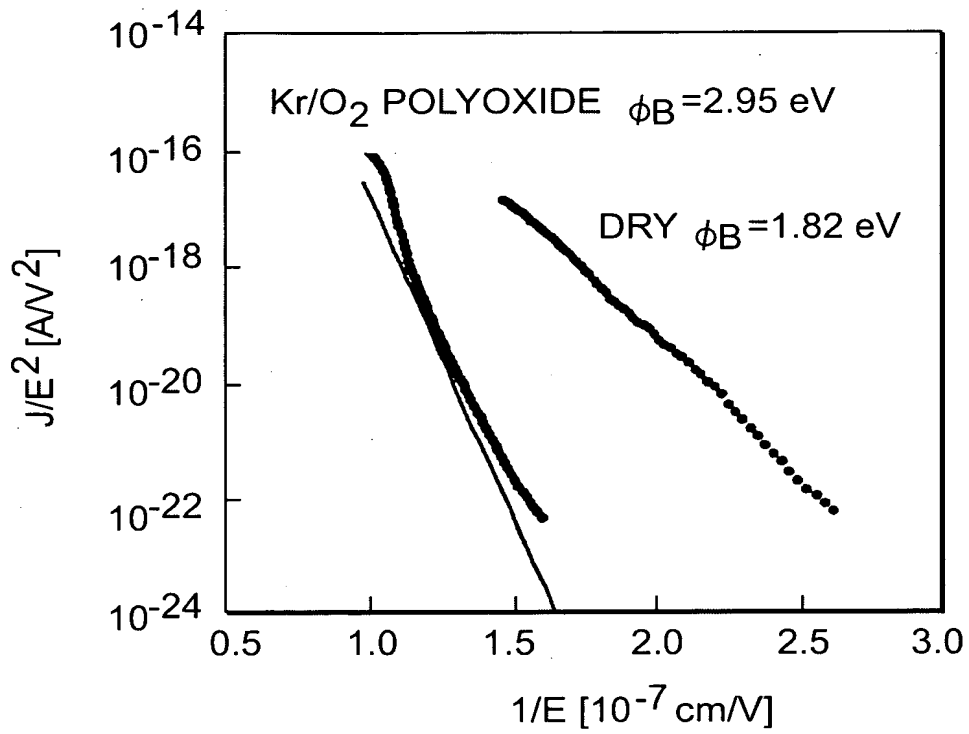

FIG. 17

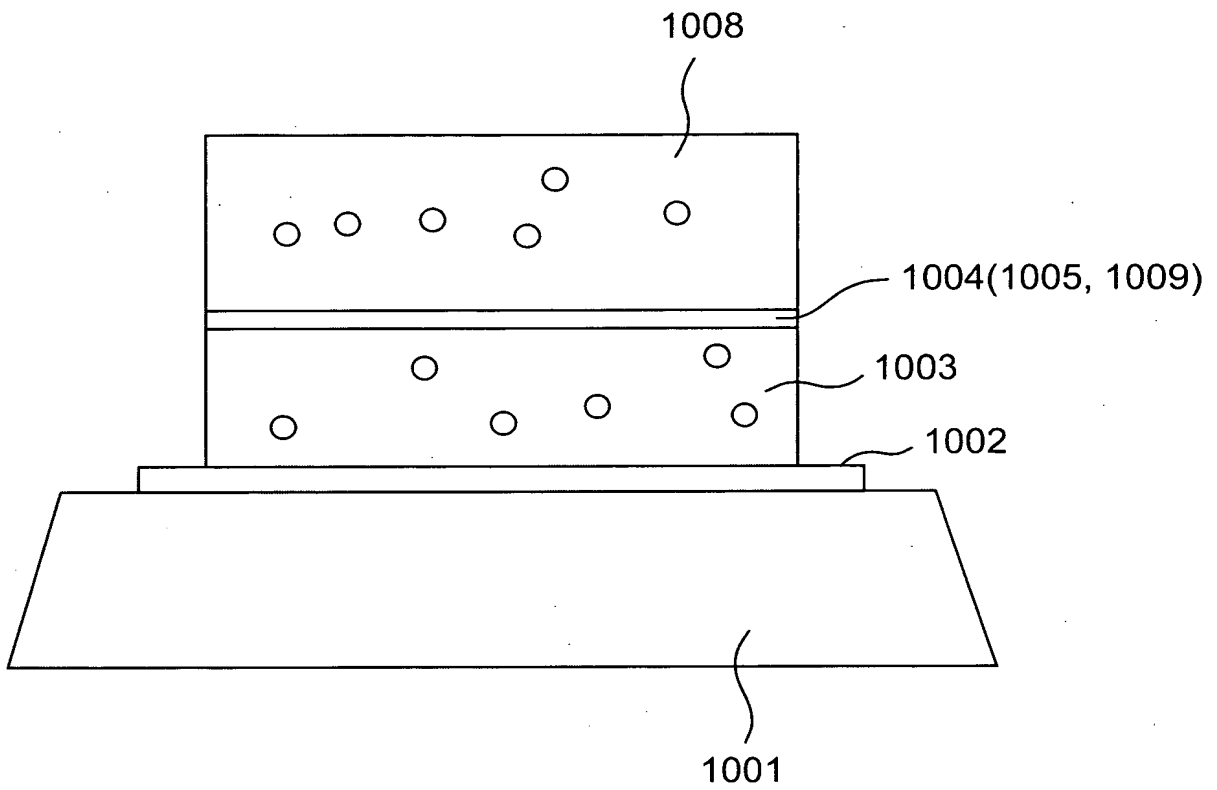

FIG. 18

1000

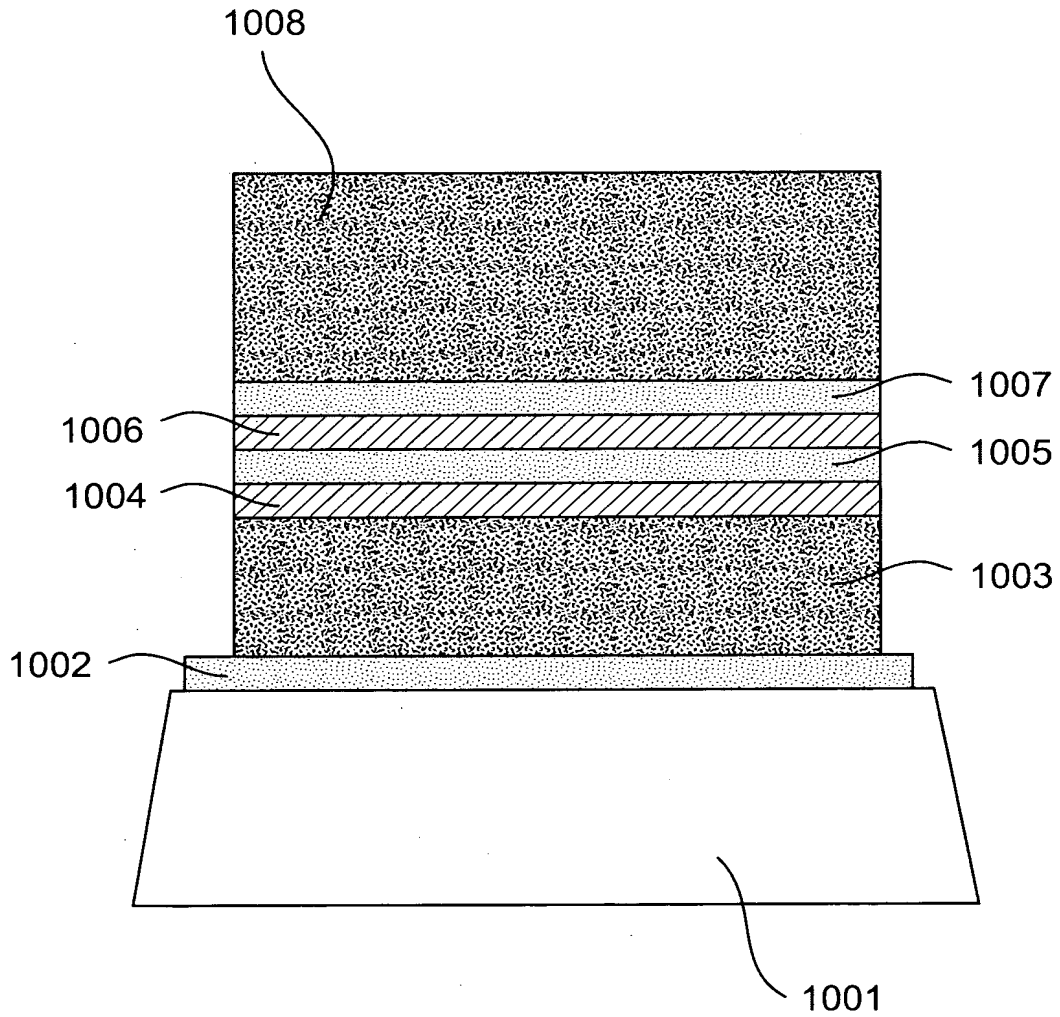

FIG. 19

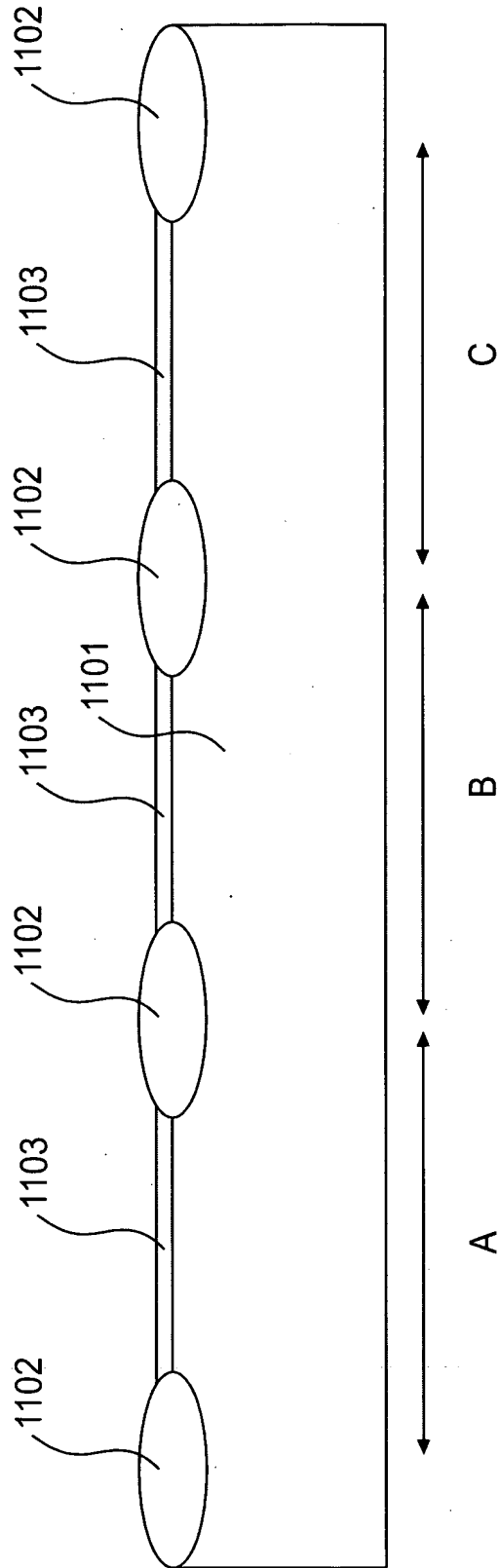

FIG. 20

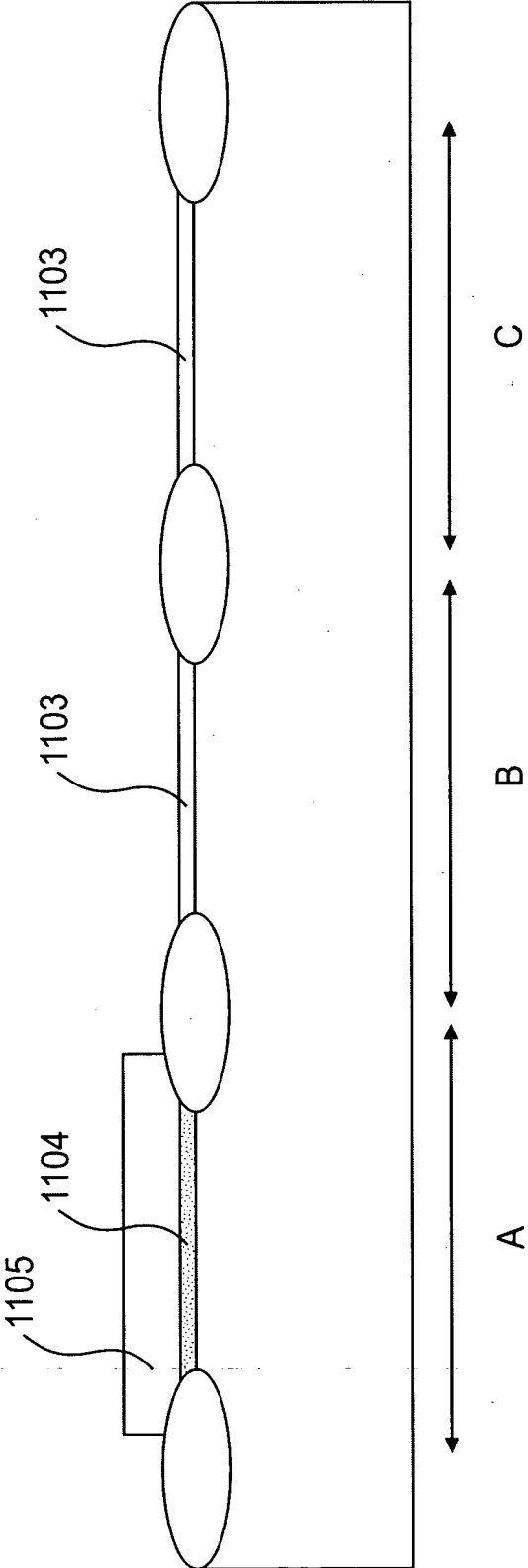

FIG. 21

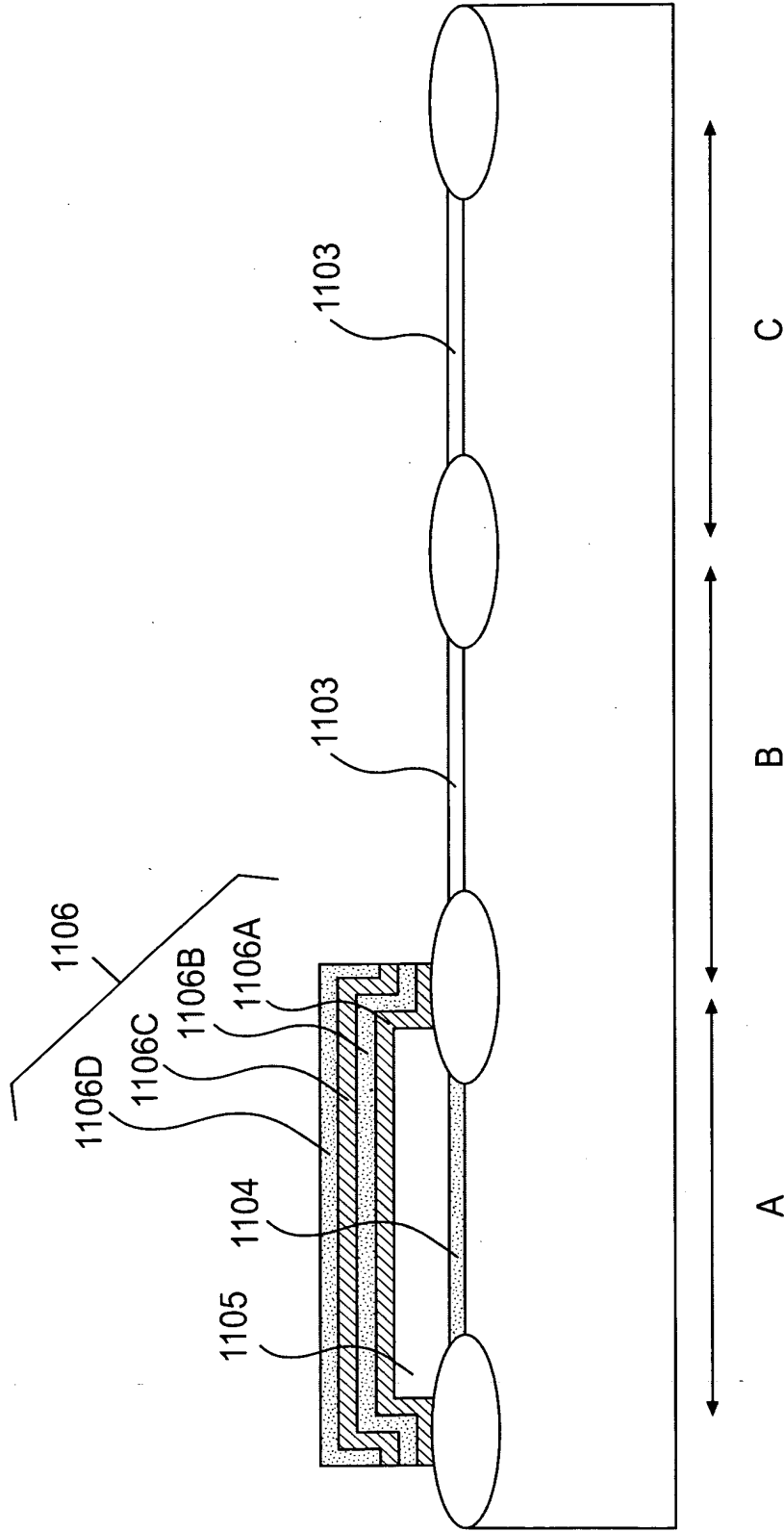

FIG. 22

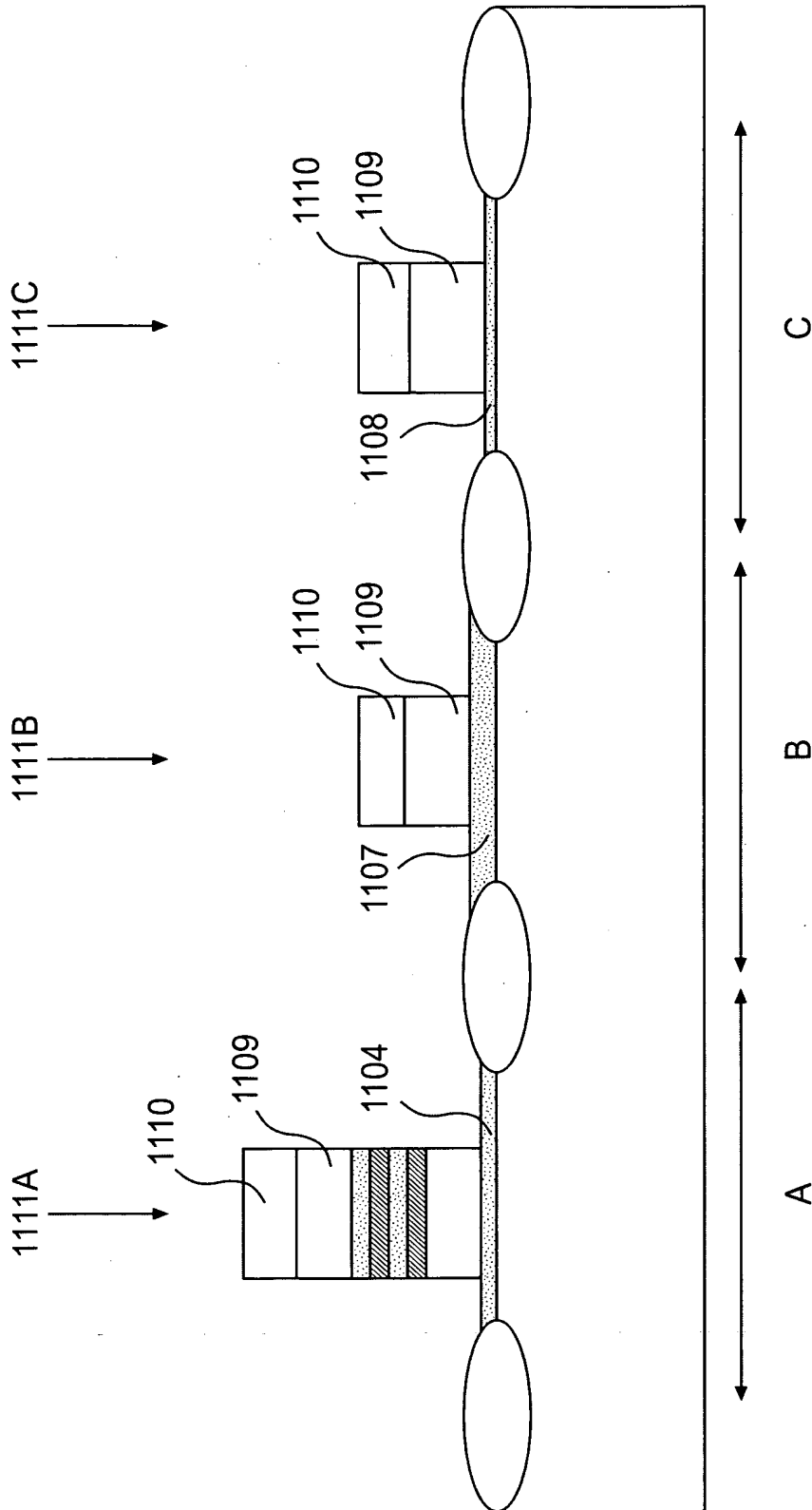

FIG. 23

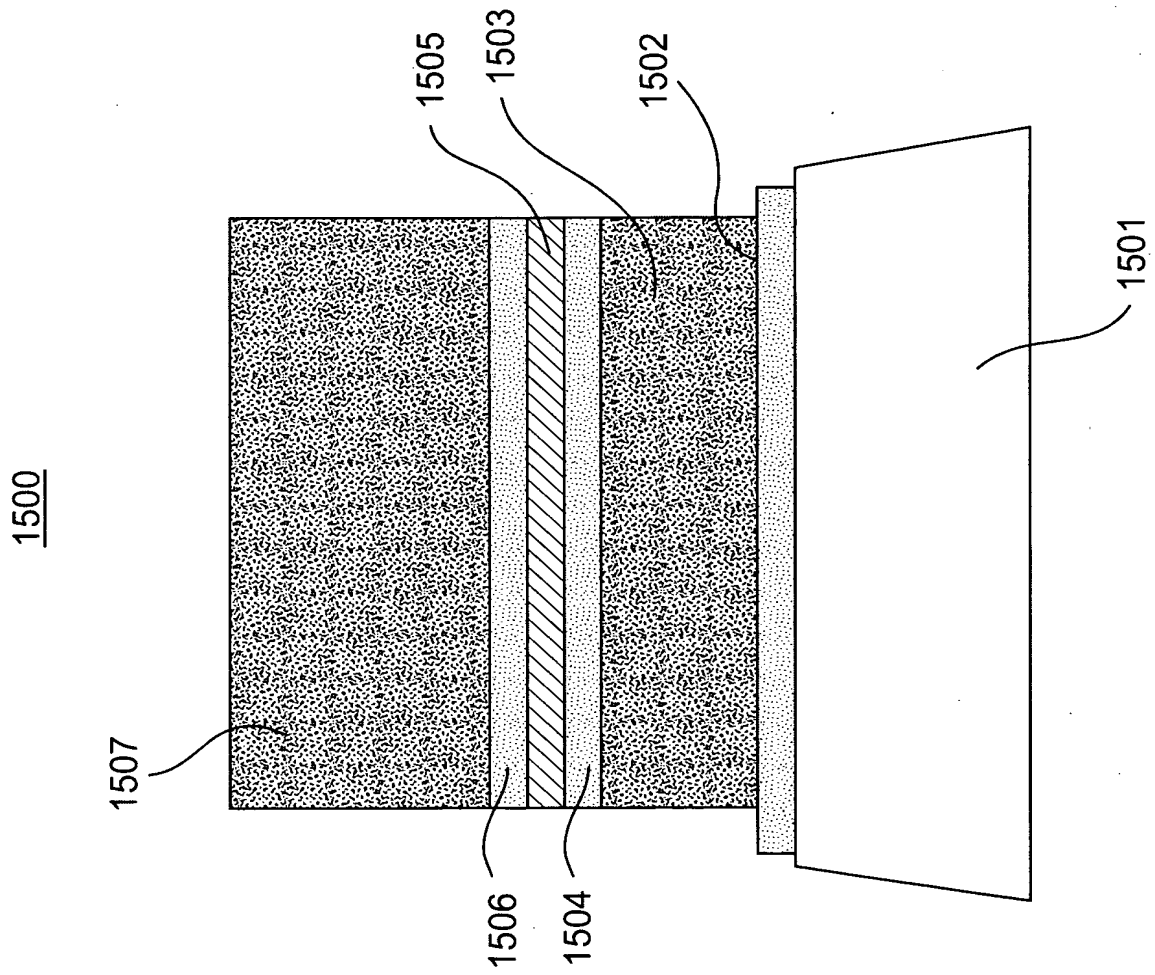

FIG. 24

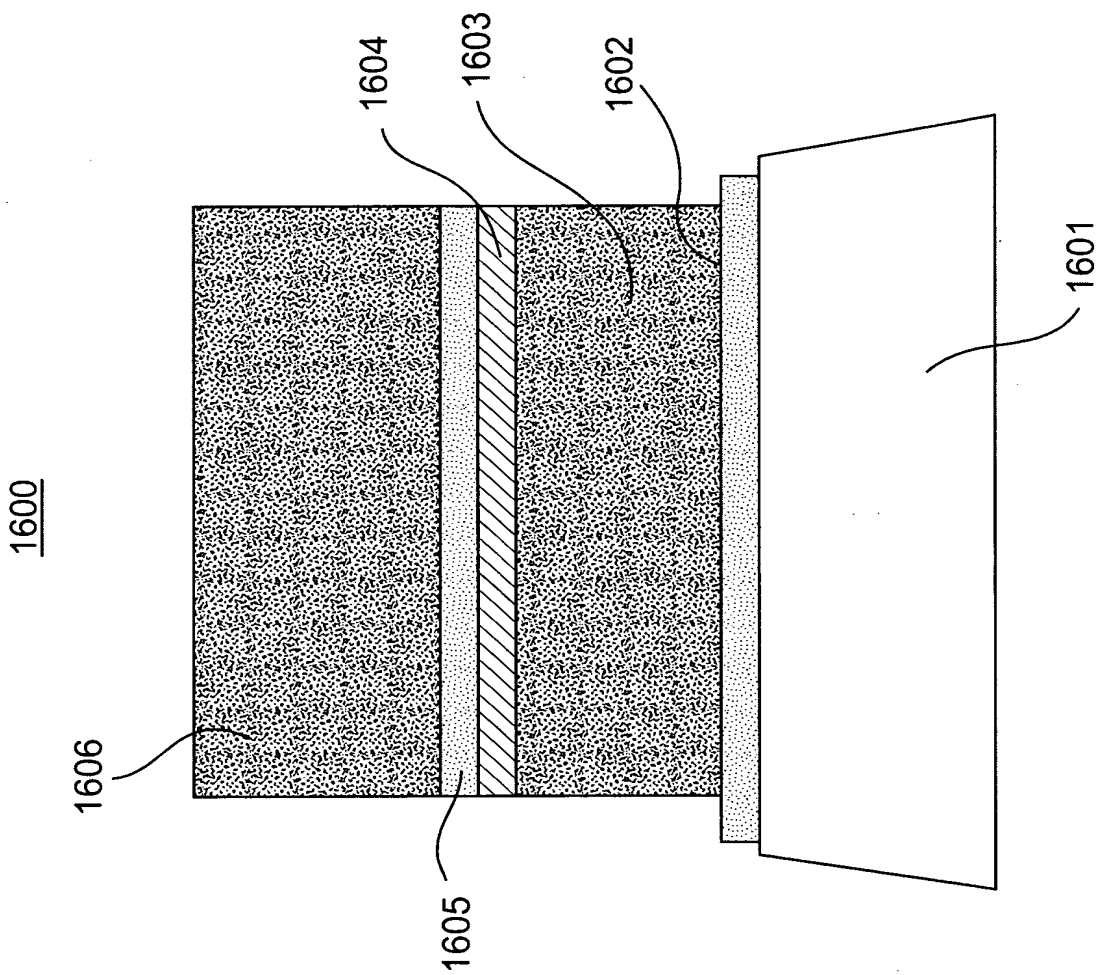

FIG. 25